

Rancang Bangun Maximum Power Point Tracking pada Panel Surya dengan Metode Incremental Conductance Menggunakan Zeta Konverter

Mahmudatul Ula, Arief Rahmadani

1-20

Sistem Informasi Proses dan Hasil Produksi Berbasis Web

Grant Ivan Nicholas Andrie, Handoko, Hartanto Kusuma Wardana

21-32

Perancangan Sendok Makan Parkinson dengan Metode PID Berbasis Arduino

Newton Onasie, Susan Sulaiman

33-48

Bearing Fault Detection Menggunakan Metode Wavelet Berbasis Labview

Romdhoni, Mardiansyah, Heri Kusnadi

49-58

Design of LTE-Wi-Fi Aggregation with Multiple Wi-Fi APs for Heterogenous Network

Eddy Wijanto, Marsellinus Bachtiar Wahju, Ronald Sukwadi

59-72

Aplikasi Pemandu Kurir Pengiriman Paket untuk Menentukan Tujuan Terdekat dengan Metoda Dijkstra Berbasis Android

Sugeng, Gregorius Christierl Bree Kumoro

73-84

Perancangan Inverter Satu Fasa Berbasis Arduino Menggunakan Metode SPWM

Lia Santoso, Arizal Mujibtamala Nanda Imron, Bambang Sri Kaloko

85-96

Monitoring Cairan Infus Menggunakan Load Cell Berbasis Internet of Things (IoT)

Phisca Aditya Rosyady, Aditya Santa Sanitya Sukarjiana, Nurina Umy Habibah, Nuni Ihsana, Ahmad Raditya Cahya Baswara, Widya Rahayu Dinata

97-110

Mapping dan Navigasi untuk Robot Pengantar Makanan di Restoran Berbasis ROS

Louise, Yohana Susanthi, Muliady

111-128

Perancangan Antena Mikrostrip Circular Patch dengan Inset-Feed dan Array pada Frekuensi 3.5 GHz untuk Sistem Komunikasi 5G

Agam Yudi Putranto, Syah Alam, Indra Surjati, Yuli Kurnia Ningsih, Lydia Sari, Permana Andi Paristiawan

129-142

Identifikasi Mangga Arumanis yang Dimatangkan dengan Kalsium Karbida (CaC₂) Menggunakan Metode Spektroskopi

Primus Putra Wahyudi, Budi Harsono

143-156

Analisis Pemakaian Energi Listrik di Kantin Kampus 2 Universitas Pamulang

Heri Kusnadi, Hafidz Nurfadilah, Mardiansyah, Romdhoni

295-307

Editorial Team

Editor-in-chief:

Dr. Iwan Setyawan (Scopus ID: 57193931420), Universitas Kristen Satya Wacana, Indonesia

Associate Editors:

Gunawan Dewantoro, M.Sc.Eng (Scopus ID: 51061207400), Universitas Kristen Satya Wacana, Indonesia

Dr.-Ing. Ivanna K. Timotius (Scopus ID: 36959911700), Universitas Kristen Satya Wacana, Indonesia

Abdi Suryadinata Telaga, Ph.D (Scopus ID: 56104037400), Politeknik Manufaktur Astra, Indonesia

Dr. Regina Lionnie (Scopus ID: 53264393700), Universitas Mercu Buana, Jakarta, Indonesia

Lesnanto Multa Putranto, Ph.D (Scopus ID: 55837147000), Universitas Gadjah Mada, Indonesia

Dr. Arta Moro Sundjaja (Scopus ID: 55858212100), Universitas Bina Nusantara, Indonesia

Dr. Fergyanto E. Gunawan (Scopus ID: 6507898893), Universitas Bina Nusantara, Indonesia

Eddy Wijanto, Ph.D (Scopus ID: 36816648600), Universitas Kristen Krida Wacana, Jakarta, Indonesia

Reviewers :

Dr. Riko Arlando Saragih (Scopus ID: 56400835700), Universitas Kristen Maranatha, Bandung, Indonesia

Albert Gunadhi, MT, IPM (Scopus ID: 56554221300), Universitas Katolik Widya Mandala, Surabaya, Indonesia

Phisca Aditya Rosyady, M.Sc (Scopus ID: 57192978094), Universitas Ahmad Dahlan, Yogyakarta, Indonesia

Dr. Ir. Bambang Sri Kaloko, ST, MT, IPM (Scopus ID: 53984218100), Univesitas Jember, Jember, Indonesia

Agus Cahyo Nugroho, M.T (Sinta ID: 6652886), Universitas Katolik Soegijapranata, Semarang, Indonesia

Widyasmoro, M.Sc (Sinta ID: 6670389), Universitas Muhammadiyah Yogyakarta, Indonesia

Darmawan Utomo, Ph.D (Scopus ID: 55847301100), Universitas Kristen Satya Wacana, Indonesia

Saptadi Nugroho, M.Sc. (Scopus ID: 56669586700), Albert-Ludwigs-Universität Freiburg, Germany

Dr. Muhamad Reza, ST., M.Sc (Sinta ID: 6631079), Universitas Telkom, Bandung, Indonesia

Handoko, Ph.D. (Scopus ID: 56082263000), Universitas Kristen Satya Wacana, Salatiga, Indonesia

Lukas B. Setyawan, M.Sc (Sinta ID: 6166190), Universitas Kristen Satya Wacana, Salatiga, Indonesia

Hartanto K. Wardana, M.T. (Scopus ID: 55847353500), Universitas Kristen Satya Wacana, Salatiga, Indonesia

Budihardja Murtianta, M.Eng. (Scopus ID: 56596841300), Universitas Kristen Satya Wacana, Salatiga, Indonesia

Andreas A. Febrianto, M.T. (Scopus ID: 54790922000), Universitas Kristen Satya Wacana, Salatiga, Indonesia

Eva Yovita D.U, M.T. (Scopus ID: 56596747500), Universitas Kristen Satya Wacana, Salatiga, Indonesia

Daniel Santoso, M.S. (Scopus ID: 53264902600), Universitas Kristen Satya Wacana, Salatiga, Indonesia

Deddy Susilo, M.Eng. (Scopus ID: 54899524300), Universitas Kristen Satya Wacana, Salatiga, Indonesia

Banu W. Yohanes, M.Comp.Sc (Scopus ID: 55847349700), Universitas Kristen Satya Wacana, Salatiga, Indonesia

Atyanta N. Rumaksari, MT, MBA (Scopus ID: 6643908), Universitas Kristen Satya Wacana, Salatiga, Indonesia

Administrasi : Anggun Arista Yudhiani, A.Md

Alamat Redaksi :

Fakultas Teknik Elektronika dan Komputer

Universitas Kristen Satya Wacana

Jl.Diponegoro 52-60, Salatiga 50711

Telp. (0298) 321212 ext. 1246

E-mail : submissions@jurnaltechne.org

Web : <http://www.jurnaltechne.org>

Penerbit :

Fakultas Teknik Elektronika dan Komputer

Universitas Kristen Satya Wacana

Salatiga

Terbit pertama kali : Oktober 2002.

Frekuensi terbit : 2 (dua) kali dalam setahun.

Kata Pengantar

Puji syukur kepada Tuhan, karena Jurnal Ilmiah Techné Volume 22, Nomor 1, April 2023 telah berhasil diterbitkan. Edisi ini semakin menguatkan trend peningkatan minat penulis dari berbagai instansi di Indonesia. Untuk itu, dengan segala kerendahan hati Redaksi mengucapkan banyak terima kasih atas kontribusi seluruh penulis.

Terus meningkatnya minat penulis harus diimbangi dengan peningkatan kualitas isi dan layanan Jurnal Ilmiah Techné. Oleh karena itu, Redaksi akan segera merilis revisi peraturan penerbitan artikel di Jurnal Ilmiah Techné. Peraturan ini akan diterapkan mulai Volume 22, Nomor 2 yang akan diterbitkan pada bulan Oktober 2023 dan akan dipublikasikan melalui website Jurnal Ilmiah Techné.

Redaksi juga tidak lupa mengucapkan banyak terima kasih kepada semua reviewer (baik dari dalam maupun luar UKSW). Kerja keras Bapak/Ibu memiliki peranan yang sangat penting dalam upaya kita bersama untuk menjaga dan meningkatkan kualitas isi artikel.

Akhir kata, Redaksi kembali mengundang partisipasi pembaca untuk mengirim naskah untuk penerbitan Jurnal Ilmiah Techné berikutnya (Volume 22, Nomor 2) yang direncanakan terbit pada bulan Oktober 2023.

Salatiga, 3 April 2023

Redaksi Techné

Design of LTE-Wi-Fi Aggregation with Multiple Wi-Fi APs for Heterogenous Network

Eddy Wijanto¹, Marsellinus Bachtiar Wahyu², Ronald Sukwadi³

Program Studi Pendidikan Profesi Insinyur,
Universitas Katolik Indonesia Atma Jaya, Jakarta

¹eddy.wiyanto@ukrida.ac.id, ²marsellinus.bachtiar@atmajaya.ac.id,

³ronald.sukwadi@atmajaya.ac.id

¹Program Studi Teknik Elektro,
Universitas Kristen Krida Wacana, Jakarta

^{2,3}Program Studi Teknik Industri,
Universitas Katolik Indonesia Atma Jaya, Jakarta

Abstract

The growth in mobile data traffic is forcing network operators to find ways to deliver higher bandwidth, better coverage, and better quality of service (QoS) at lower development costs. One method that can be used to meet this need is the aggregation technique. Aggregation techniques that run on several different technologies are called heterogeneous networks (HetNet). Recently, some advanced technologies have been proposed to aggregate different long-term evolution (LTE) carriers or different radio access technologies (RAT) to generate higher bandwidth. Many efforts have been made to improve the throughput of heterogeneous networks. One of the factors that affects the maximum LTE-WLAN aggregation (LWA) throughput is the Wi-Fi access point (AP) signal strength. Since the power of small cells is very low, the LWA range is not very large, so the LWA range needs to be increased. This paper proposes the solution that can be implemented by using multiple Wi-Fi APs scheme. From the experiments, it found that LWA with multiple Wi-Fi APs has better signal strength than LWA with a single Wi-Fi AP. LWA with multiple Wi-Fi APs further increase the coverage of the network.

Keywords: HetNet, LTE, WLAN, LWA, Wi-Fi AP, throughput

1. Introduction

The dramatic increase in mobile data traffic is pushing operators to find ways to deliver higher bandwidth, wider coverage, and better Quality of Service (QoS) at lower development costs. One of the solutions that can be used to answer this need is aggregation technique. The aggregation technique carried out on several different technologies which is known as the heterogeneous network (HetNet) [1]. A HetNet which is connecting devices with different systems and/or protocols is one of potentials technology for 5G [2]. The 5G technology requirements of low latency, high connection density, and high throughput can be supported with HetNet.

Recently, some advanced technologies have been proposed to aggregate different long-term evolution (LTE) carriers or different radio access technology (RATs) to

generate higher bandwidth [3]. In addition to LTE bandwidth aggregation, inter-RAT aggregation or offloading is another cost-effective solution for gaining bandwidth [4]. One of the HetNet technologies is to aggregate between LTE and Wi-Fi. Wi-Fi is chosen because it has high availability and has advantages in indoor coverage. Wi-Fi is often used by carriers to supplement the bandwidth needs of existing mobile infrastructure such as LTE. Traditionally, wireless local area network (WLAN) and LTE operated independently of each other. LTE WLAN aggregation (LWA) is recently seen as a better use of Wi-Fi and LTE.

Many efforts have been made to increase the throughput of HetNet [5]. Optimal queuing and resource allocation problems of three-tier HetNet based on LTE Wi-Fi aggregation for offloading voice/multimedia traffic from licensed to unlicensed using scalable media access control (MAC) protocol (SC-MP) latency constraints has been observed in [6]. Further, the impact of bursty traffic in LTE and Wi-Fi aggregation enabled networks, where some of the LTE traffic is offloaded to Wi-Fi access points (APs) to improve LTE performance was analyzed in [7]. LWA combines LTE and WLAN radio resources to take advantage of Wi-Fi high availability and indoor coverage to make better use of WLAN and LTE. The key to this mechanism is that the network intelligently switches the data radio bearer (DRB) to use either LTE or Wi-Fi. The findings in [8] implements the radio resource management (RRM) layer of LWA and proposes two types of switched LWA policies to guaranteed bandwidth and the equal sharing policies. However, LWA requires careful partitioning of traffic between LTE and Wi-Fi resources to avoid overloading the link and to achieve good load balancing among co-located network nodes [9].

For split DRB, it is important to determine the LTE-WLAN ratio (LWR), which is the proportion of packets delivered by LTE over WLAN. Lin et al. [10] proposed a simple LWR selection rule based on the received signal strength indicator (RSSI) of the WLAN to describe the user-level implementation of LWA. The LWA adaptive routing scheme can be easily implemented at the RRM and packet data convergence protocol (PDCP) layers of the LTE evolved node B (eNB) [10]. In [11], a user-offloading algorithm was proposed for eNB hardware that smartly allocates the deprived LTE user equipments (UEs) and assigns the LWA service to an optimal number of UEs without degrading the QoS for existing WLAN UEs.

The LWA network reuses and integrated with existing individual LTE and Wi-Fi networks [12]. Unlicensed bands are attracting a lot of attention in the heterogeneous deployment of 5G. LWA, specified in 3GPP Release 13, is seen as an effective approach for frequency aggregation of heterogeneous 5G networks.

One of the factors that effects the maximum throughput of the LWA is the signal strength of Wi-Fi AP. Since the power of small cells is quite low, the LWA range is not very long, so the LWA range needs to be increased. One method that can be applied is to use multiple Wi-Fi APs. Using multiple Wi-Fi APs is basically an extension of a single Wi-Fi AP, with some configuration changes, including handoff and load balancing. In this paper, an LTE-Wi-Fi aggregation for heterogeneous network is designed and implemented with multiple Wi-Fi APs to increase the LWA performance. Further, the performance of multiple Wi-Fi APs LWA was analyzed in comparison with the single Wi-Fi AP scheme. In addition, multiple Wi-Fi APs LWA mobility or handoff was verified. The implementation of multiple Wi-Fi APs LWA brings a potential to increase the throughput and coverage of the LWA and further increase the LWA performance.

The remainder of this paper is organized as follows. Section 2 describes the system design of multiple Wi-Fi APs LWA used in this research. Section 3 presents the multiple Wi-Fi APs LWA system implementation. Section 4 presents the results and discussion. Finally, last section concludes the work along with the proposed future work.

2. LWA with Multiple Wi-Fi APs System Design

The HetNet topology is represented in Figure 1 as a collection of k base stations (BS), each of which is connected to a collection of relay stations (RS), with m representing the total number of RS in the network. The BS and its associated RS are represented as clusters that serve a group of users [13].

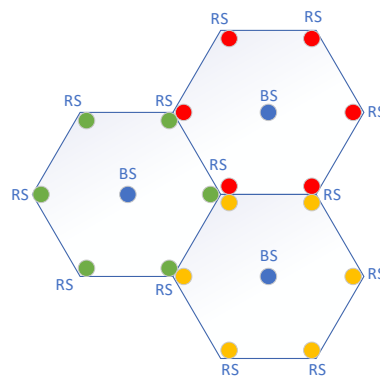

Figure 1. HetNet topology

The hardware configuration of LWA with single and multiple Wi-Fi APs scheme is shown in Figure 2. The multiple Wi-Fi APs is similar to the single Wi-Fi AP scheme, except for one additional Wi-Fi AP and one additional switch. The additional switch is used to transfer data from the eNB to different Wi-Fi APs. In this scheme, two Wi-Fi APs are connected to the same eNB and the coverage of these two APs is partly overlapping. In the beginning, the UE is in the coverage of AP#1 and LWA is activated. Further, when the UE moves toward AP#2, in order to maintain LWA connection, Wi-Fi AP change procedure should be initiated.

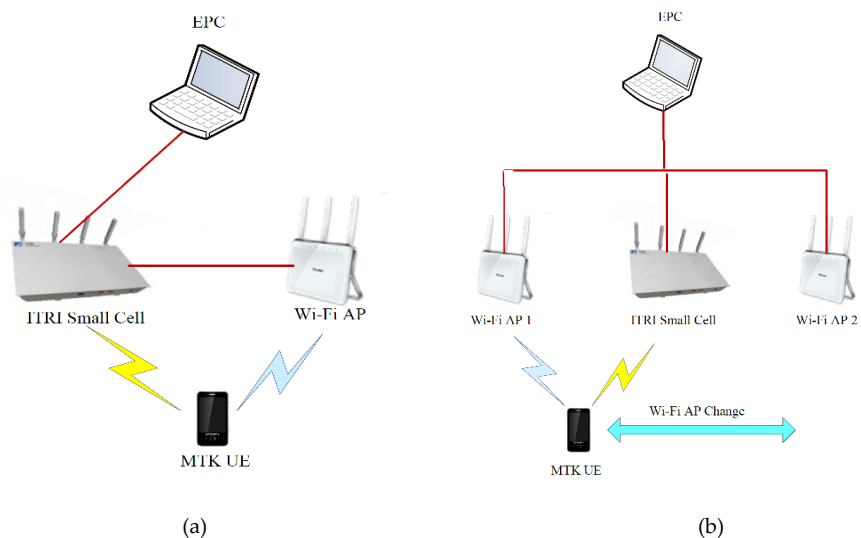

Figure 2. Hardware configuration (a) single Wi-Fi AP (b) multiple Wi-Fi APs

Figure 3 presents the block diagram of LWA system with two Wi-Fi APs. For higher number of Wi-Fi APs scheme can be expanded with similar configuration.

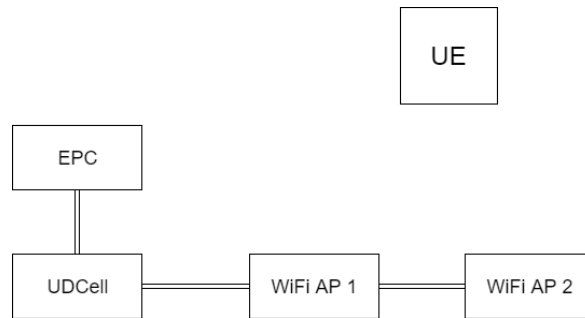

Figure 3. LWA with multiple Wi-Fi APs system

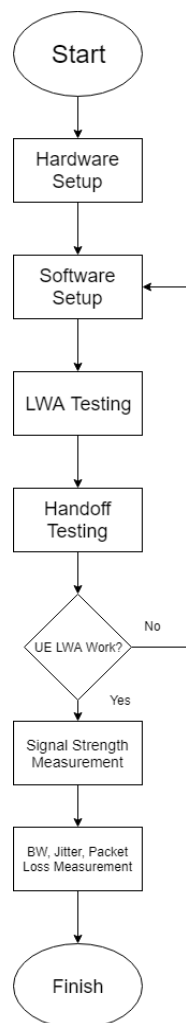

Figure 4. Flowchart of LWA with multiple Wi-Fi APs performance measurement

In order to implement the LWA system with multiple Wi-Fi APs scheme, some hardware was used. An ITRI LTE UDCell was implemented as the small cell. Two Wi-Fi APs with the same specifications was used and connected to UDCell via switch. For evolved packet core (EPC), a notebook was used. One mobile phone is used as the UE for LWA and one dongle set Huawei E3372h607 was implemented. An ITRI LTE-small cell

technology features 32 users online at the same time; smart antenna function; 2x2 MIMO; antenna with 27 switchable beams; support intra-band carrier aggregation; advanced self-organized networking (SON) function; provides standard Femtocell API (FAPI) for developers to flexibly enhance system functionality; and flexible software defined radio (SDR) platform. Some software used in this paper are Network Draw, iPerf, Wi-Fi Analyzer, and Advanced Signal Status.

Before performance measurement is carried out, hardware and software setup are performed first. To ensure that LWA is working properly, a testing is performed using iPerf and the results are observed with Network Draw. The next step is conducted to make sure the UE can do handoffs from one Wi-Fi AP to another Wi-Fi AP. If the UE cannot do handoff, it is necessary to check and set the software. If the UE can do handoff properly, further the experiment is continued by measuring the signal strength of LWA with multiple Wi-Fi APs. The measured signal strength includes reference signal received power (RSRP), receive signal strength indicator (RSSI), reference signal received quality (RSRQ), and signal to noise ratio (SNR). The next measurement is bandwidth, jitter, and packet loss in LWA with multiple Wi-Fi APs. The flowchart of performance measurement on LWA with Multiple Wi-Fi APs is depicted in Figure 4.

Both Wi-Fi APs are connected to the same eNB and the coverage of these two APs is partly overlapping. Several LWA status are as follows:

a. LWA Activation and Deactivation

In the condition that WLAN becomes better than a threshold, LWA is activated. While the UE enters the coverage of Wi-Fi and the signal strength is larger than an activation threshold, the eNB triggers the activation procedure. On the contrary, in the condition that all WLAN inside WLAN mobility becomes worse than a threshold, LWA is deactivated. If the signal strength is smaller than a deactivation threshold, the eNB triggers the deactivation procedure. Figure 5 depicts the LWA activation and deactivation.

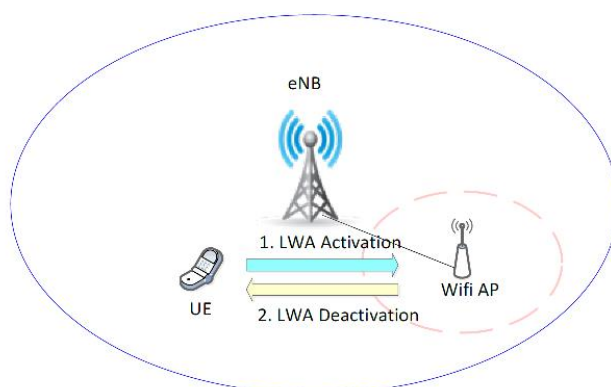

Figure 5. LWA activation and deactivation

b. Wi-Fi AP change

In case of multiple Wi-Fi APs scheme, one of the challenges is handoff between Wi-Fi AP. In the condition that all WLAN inside WLAN mobility set becomes worse than threshold#1 and a WLAN outside WLAN mobility set becomes better than threshold#2, the Wi-Fi AP change procedure is activated. Figure 6 demonstrates the Wi-Fi AP change procedure. When the UE moves towards AP#2's coverage and detects AP#2's signal, it returns the signal strength of both

APs. If the signal strength of AP#1 is worse than threshold#1 and the signal strength of AP#2 is better than threshold#2, the eNB will send a radio resource control (RRC) message to triggers the Wi-Fi AP change procedure.

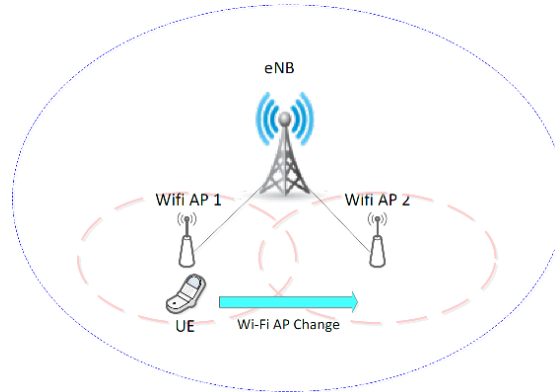

Figure 6. Wi-Fi AP change

3. LWA with Multiple Wi-Fi APs System Implementation

In the hardware configuration for two Wi-Fi APs, the second Wi-Fi AP is connected to the first Wi-Fi AP by using an RJ45 cable. Figure 7 shows the hardware configuration for two Wi-Fi Aps scheme.

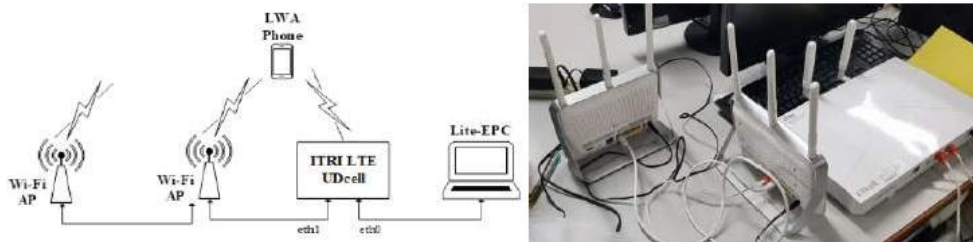
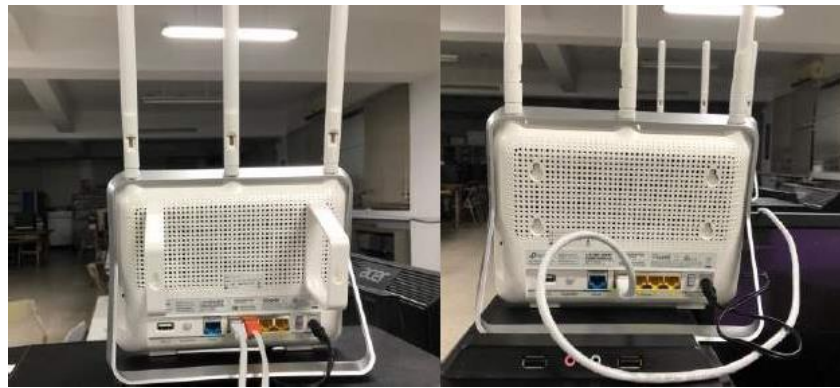

Figure 7. Hardware configuration scheme for two Wi-Fi APs

The first Wi-Fi AP connects the LAN port on the ITRI UDeCell LTE to the Ethernet port on the Wi-Fi AP by using the High-Speed LAN cable Cat 6. The second Wi-Fi AP connects the Ethernet port on the first Wi-Fi AP to the Ethernet port on the second Wi-Fi AP by using the High-Speed LAN cable Cat 6. Figure 8 present the connection for the first and second Wi-Fi AP, respectively.

For Wi-Fi AP change procedure, known as handoff testing between two Wi-Fi APs, a considerable distance is needed. The testing was conducted in the electrical engineering room with the configurations shown in Figure 9.

In order to be connected via the switch, both Wi-Fi APs have to be connected to LAN port that has the same netmask. The netmask used is 140.130.19.xxx. Both Wi-Fi APs are connected to LAN ports in two different rooms where the two rooms are about 60 m apart. Figure 10 depicts the Wi-Fi AP in both rooms.



(a) (b)

Figure 8. Wi-Fi AP connection (a) single Wi-Fi AP (b) multiple Wi-Fi APs

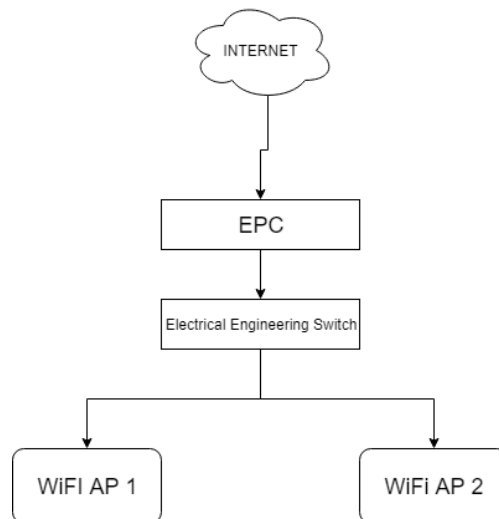

Figure 9. Hardware configuration for two Wi-Fi APs using switch



(a) (b)

Figure 10. Wi-Fi AP (a) room 1 (b) room 2

Because more than one Wi-Fi AP device is used, it is necessary to set the service set identifier (SSID) and MAC Address settings on the device. Before running UDCell terminals, some LWA configuration changes need to be made to use multiple Wi-Fi APs. The mac address setting (mac_addr) was performed for all Wi-Fi APs to be used. Threshold are also set in this step. Figure 11 shows the LWA configuration.

```
#=====
#   WLAN ap lists
#=====
# mac addr format : xx:xx:xx:xx:xx:xx
# Current most ap number:8
wlan_ap_num=2

mac_addr1=D8:0D:17:E8:9B:3E
mac_addr2=10:BF:48:D4:C3:03
#mac_addr1=B0:BE:76:0B:B0:72

SSID=lwa_iot_5G

#
#=====
#   LWA activation threshold
#=====
thresh_act= -60
thresh_de_act=-101
thresh_ho_serv= -61
thresh_ho_neigh= -70

#=====
#   Measurement report config
#=====
# Report Interval (ReportInterval in 36.331-d10 p408)
# 0: 120ms, 1: 240ms, 2: 480ms, 3: 640ms, 5: 2048ms, 6: 5120ms
# 7: 10240ms 8: 1 min, 9: 6min, 10: 12min, 11: 30min, 12: 60min
report_interval=8
```

Figure 11. LWA configuration

In order to run the LWA device, all terminals need to be open and the settings need to be conducted for each terminal, include L1/L2, RRC, mobility management entity (MME), radio resource management (RRM), Serving-Gateway configuration, Serving-Gateway execution, multi-cell selection (MCS) and LWA ratio change, and iPerf traffic generator.

4. Results and Discussion

After the hardware and software setup is completed, an experiment is carried out in order to proof that the system is working properly. The LWA throughput was observed by using iPerf. The results of LWA throughput, which is observed in the network draw application, shows that by using a 1:3 ratio, LWA has been able to produce a throughput of 43.5 Mbps which is the aggregate between Wi-Fi (32.7 Mbps) and LTE (10.8 Mbps) as presented in Figure 12. This result confirms that the LWA was working properly.

Wi-Fi Analyzer application was applied to ensure that both Wi-Fi APs are functioning well. From the results of the experiment shown in Figure 13, it can be seen that both Wi-Fi APs are functioning properly with signal strength of -35 dBm and -38 dBm.

In order to observe the handoff of the UE, from one Wi-Fi AP to another Wi-Fi AP, an experiment was performed by disabling one of the Wi-Fi APs. The Wi-Fi APs disabling cannot be done by turning off the Wi-Fi AP resource because Wi-Fi AP#1 and Wi-Fi AP#2 are directly connected each other. Therefore, the deactivation process is done through

software configuration. From the results of the experiment, it can be found that when Wi-Fi AP#1 is disabled, the LWA still works on the UE with the aggregation of LTE and Wi-Fi AP#2.

In the Wi-Fi AP analyzer depicted in Figure 14, it can be seen that the LWA still works with the remaining one Wi-Fi AP with signal strength of -44 dBm. The same result is also obtained when Wi-Fi AP#2 is disabled, the LWA still works on the UE with the aggregation of LTE and Wi-Fi AP#1. This result proved that the UE has been able to change the Wi-Fi AP or do the handoff procedure.

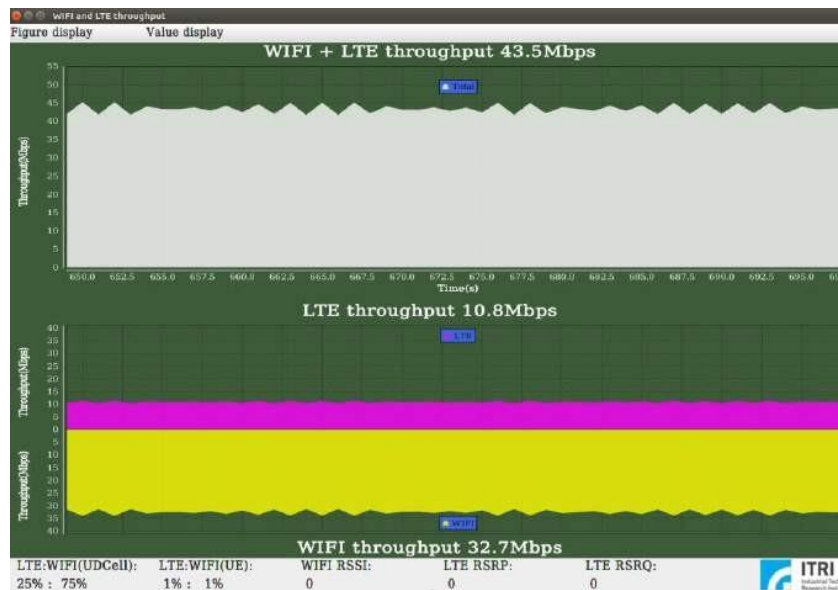

Figure 12. LWA throughput



Figure 13. Signal strength of Wi-Fi AP 1 and 2



Figure 14. Signal strength of Wi-Fi AP#2

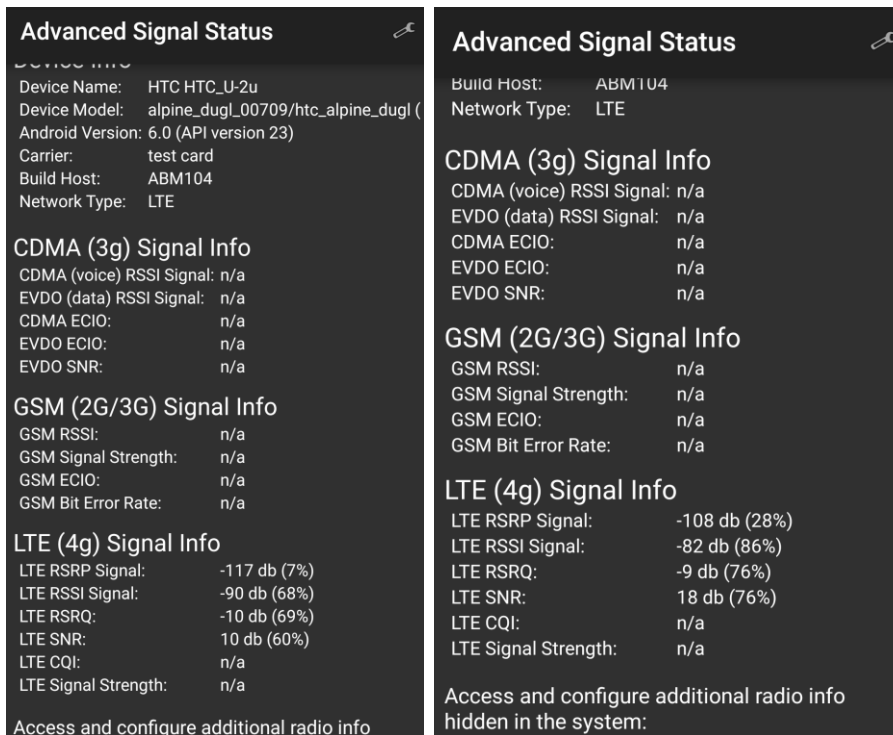

(a)

(b)

Figure 15. Signal strength (a) single Wi-Fi AP (b) two Wi-Fi APs

Further experiment is LWA with multiple Wi-Fi APs performance measurement. The parameters measured are as follows:

- a. Signal Strength (RSRP, RSSI, RSRQ, SNR)
- b. Bandwidth

- c. Jitter
- d. Packet Loss

To find out the quality of signal strength, measurements were conducted with the single Wi-Fi AP scheme and multiple Wi-Fi APs scheme. Signal quality is displayed on a scale from 0 (worst) to 100% (best). From the results of the experiment presented in Figure 15 and 16, it can be found that the signal strength when there are two Wi-Fi APs better than when there is only one Wi-Fi AP serves, including RSRP, RSSI, RSRQ, and SNR. The RSRP in the two Wi-Fi APs scheme has increased by 300% compared to the single Wi-Fi AP scheme. The RSSI in the two Wi-Fi APs scheme has increased by 27% compared to the single Wi-Fi AP scheme. The RSRQ in the two Wi-Fi APs scheme has increased by 10% in comparison with the single Wi-Fi AP scheme. The SNR in the two Wi-Fi APs scheme has increased by 27% compared to the single Wi-Fi AP scheme.

Measurement of bandwidth, jitter, and packet loss, was conducted by using iPerf. Figure 17 shows the measurement results from iPerf, including bandwidth, jitter, and packet loss measurements. Further, Figure 18 displays the bandwidth comparison, in which when there are two Wi-Fi APs, the average bandwidth decreases 36% on average compared to when there is only one Wi-Fi AP serving since the coverage of LWA has increased. It can be seen from Figure 19, for LWA with two Wi-Fi APs, the jitter has increased 81% on average compared to when only one Wi-Fi AP is serving, but in the long run, the jitter in the two Wi-Fi AP scheme is lower on average than in the single Wi-Fi AP scheme. For packet loss, Figure 20 depicts the comparison where packet loss in LWA with two Wi-Fi APs on average has increased 6% compared to when there is only one Wi-Fi AP that works. Both jitter and packet loss on LWA with two Wi-Fi APs are affected by the increase in coverage area.

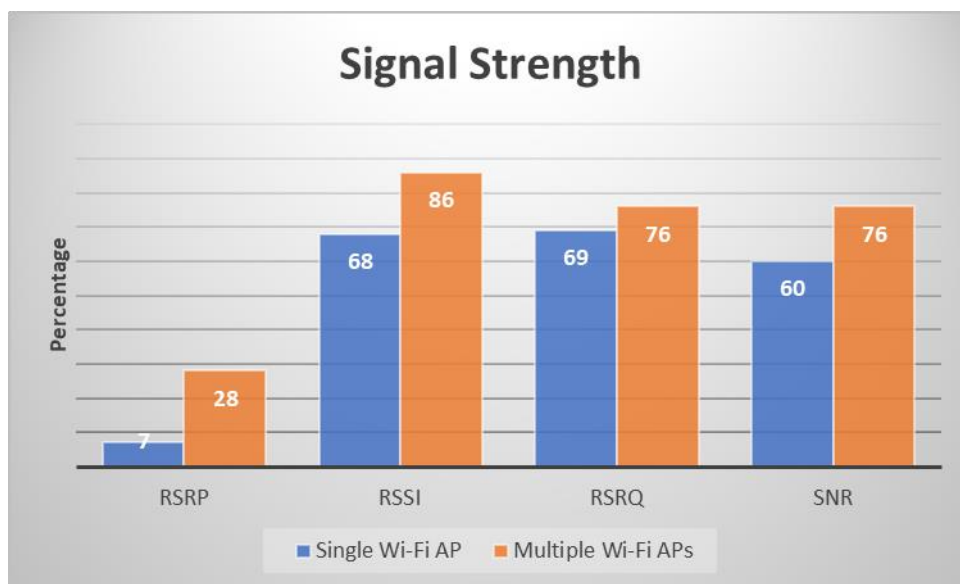

Figure 16. Signal strength for single and two Wi-Fi APs comparison



(a)

(b)

Figure 17. Bandwidth, Jitter, Packet Loss (a) single Wi-Fi AP (b) two Wi-Fi APs

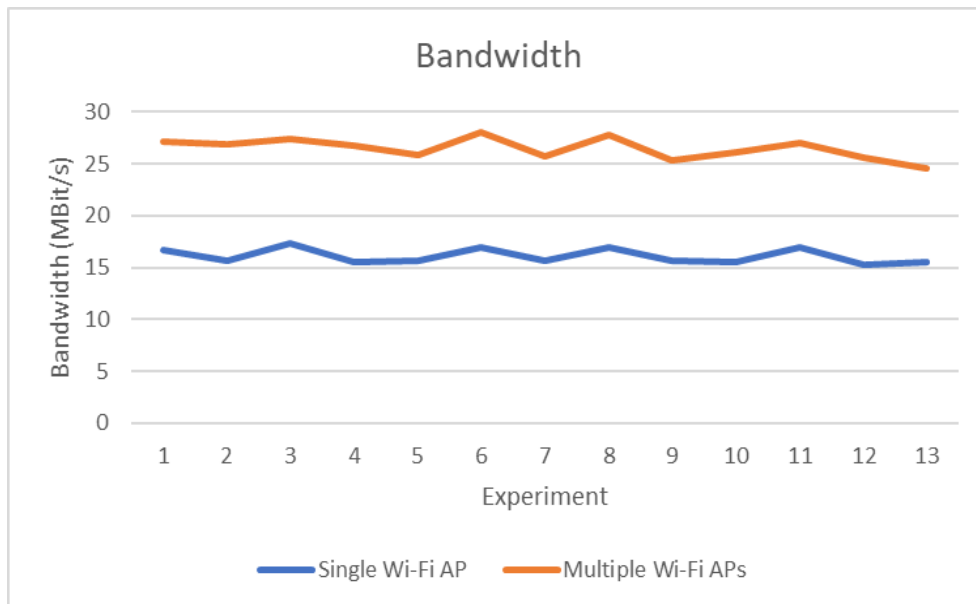

Figure 18. Bandwidth for single Wi-Fi AP and two Wi-Fi APs comparison

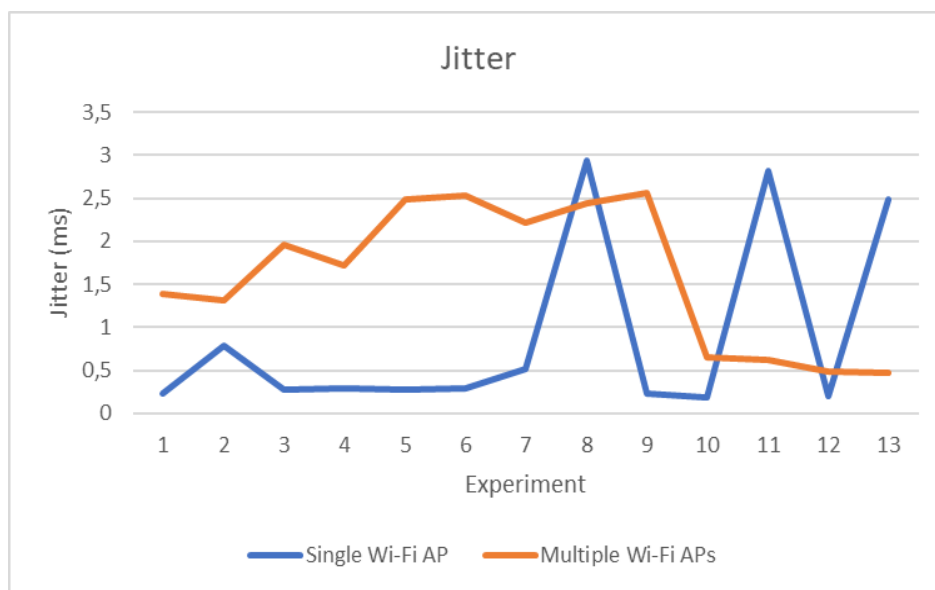

Figure 19. Jitter for single Wi-Fi AP and two Wi-Fi APs comparison

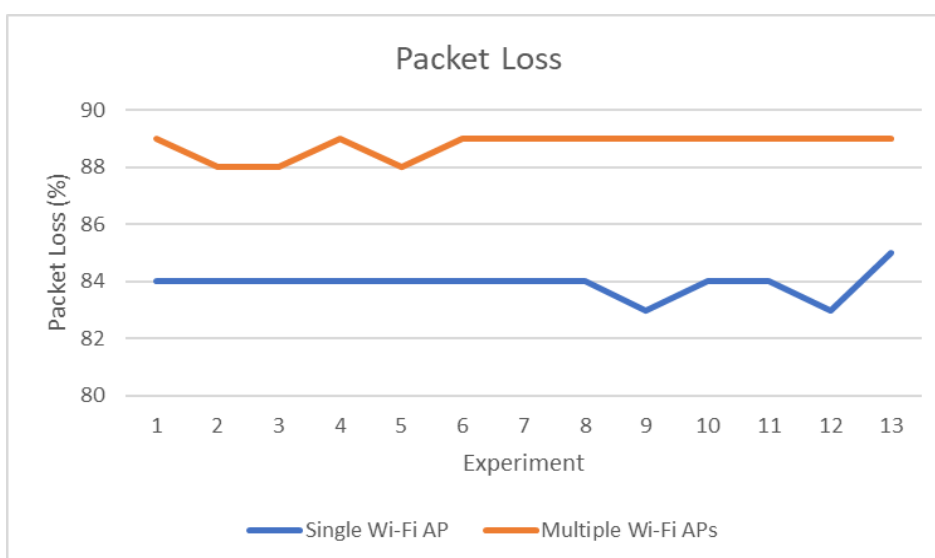

Figure 20. Packet Loss for single Wi-Fi AP and two Wi-Fi APs comparison

5. Conclusion

An LTE-Wi-Fi aggregation for heterogeneous network increase the network performance. The implementation of multiple Wi-Fi APs LWA proposed in this paper brings a potential to increase the throughput and coverage of the LWA and further increase the LWA performance. Further, the range of LWA can be increased by adding the number of Wi-Fi AP. The UE has been able to change the serving Wi-Fi AP by performing the handoff procedure. In the handoff, it is necessary to set proper distance between the Wi-Fi AP to prevent frequently handoff, which can increase UE battery usage. LWA with multiple Wi-Fi APs has better signal strength compared to LWA with single Wi-Fi AP, including RSRP, RSSI, RSRQ, and SNR. Bandwidth in an LWA with multiple Wi-Fi APs is lower than an LWA with a single Wi-Fi AP with the trade-off in increasing LWA coverage. Jitter and packet loss in LWA with multiple Wi-Fi APs are

higher than LWA with single Wi-Fi AP, but in the long run, the jitter in the two Wi-Fi AP scheme is lower in average than in the single Wi-Fi AP scheme. Further work will focus to LWA with dense Wi-Fi Aps scheme and decrease packet loss in LWA with multiple Wi-Fi APs.

References

- [1] S. Euttamarajah, Y.H. Ng, C.K. Tan, "Energy-efficient joint base station switching and power allocation for smart grid-based hybrid-powered CoMP-enabled HetNet," *Future Internet*, 13, 213, 2021. Doi: 10.3390/fi13080213.
- [2] B. Liu, Q. Zhu, H. Zhu, "Delay-aware LTE WLAN aggregation for 5G unlicensed spectrum usage," 2017 IEEE 85th Vehicular Technology Conference (VTC Spring), 2017, pp. 1-7. Doi: 10.1109/VTCSpring.2017.8108611.
- [3] N.A. Elmosilhy, M.M. Elmesalawy, A.M. Abd Elhaleem, "User association with mode selection in LWA-based multi-RAT HetNet," *IEEE Access*, vol. 7, pp. 158623-158633, 2019. Doi: 10.1109/ACCESS.2019.2949035.
- [4] Y.-J. Shih, "Control plane design and implementation for LTE-WLAN aggregation (LWA)," *ICT Journal*, 168, 2016.
- [5] X.R. Jing, Y.X. Chen, Q.B. Chen, "Analysis of coverage probability in NOMA-HetNet based on Matern cluster process," *Journal on Communications*, vol. 41, no. 9, pp. 147-159, 2020. Doi: 10.11959/j.issn.1000-436x.2020150.
- [6] B. Ismaiel, M. Abolhasan, W. Ni, D. Smith, D. Franklin, E. Dutkiewicz, Eryk, M. Krunz, A. Jamalipour, Abbas, "PCF-based LTE Wi-Fi aggregation for coordinating and offloading the cellular traffic to D2D network," *IEEE Transactions on Vehicular Technology*, 2018. Doi: 10.1109/TVT.2018.2873732.
- [7] B. Chen, N. Pappas, Z. Chen, D. Yuan, J. Zhang, "LTE-WLAN aggregation with bursty data traffic and randomized flow splitting," *ICC 2019 - 2019 IEEE International Conference on Communications (ICC)*, 2019, pp. 1-6. Doi: 10.1109/ICC.2019.8761723.
- [8] Y.-B. Lin, Y.-J. Shih, P.-W. Chao, "Design and implementation of LTE RRM with switched LWA policies," *IEEE Transactions on Vehicular Technology*, vol. 67, no. 2, pp. 1053-1062, 2018. Doi: 10.1109/TVT.2017.2751063.
- [9] S. Bayhan, A. Zubow, "Enabling flexibility of traffic split function in LTE-WiFi aggregation networks through SDN," *WSA 2018; 22nd International ITG Workshop on Smart Antennas*, 2018, pp. 1-8.
- [10] Y.-B. Lin, H.-C. Tseng, L.-C. Wang, L.-J. Chen, "Performance of splitting LTE-WLAN aggregation," *Mobile Networks and Applications*, vol. 24, no. 2, 2019. Doi: 10.1007/s11036-018-1179-8.
- [11] R. Bajracharya, R. Shrestha, S. Kim, "An admission control mechanism for 5G LWA," *Sustainability*, vol. 10, no. 6, 2018. Doi: 10.3390/su10061999.
- [12] Y.-K. Tu, C.-H. Lee, C.-H. Liu, C.-Y. Chia, Y.-K. Chen, Y.-B. Lin, "Deployment of the first commercial LWA service," *IEEE Wireless Communications*, vol. 24, no. 6, pp. 6-8, 2017. Doi: 10.1109/MWC.2017.8246817.
- [13] A. Al-Samawi, A. Sali, N. Noordin, M. Othman, F. Hashim, M. Nisirat, "Feasibility of Green Network Deployment for Heterogeneous Networks," *Wireless Personal Communications*, vol. 94, 2017. Doi: 10.1007/s11277-016-3691-0.

Informasi untuk Penulis

Jurnal Ilmiah Elektroteknika Techné diterbitkan setiap bulan April dan Oktober. Kajian ilmu yang tercakup meliputi bidang-bidang elektroteknik baik yang menyangkut perangkat keras maupun perangkat lunak. Naskah yang dimuat menampung karya-karya berupa:

1. Laporan hasil penelitian, ide-ide atau inovasi perkembangan bidang elektro teknik.
2. Penjelasan rinci tentang topik-topik baik yang baru maupun yang lama dalam bentuk tutorial yang disajikan secara inovatif dan baru dalam metode penyajiannya.

Naskah-naskah di atas harus belum pernah diterbitkan maupun sedang dipertimbangkan penerbitannya di penerbitan lain.

Naskah yang diajukan akan dinilai oleh 2 (dua) penilai yang ditetapkan oleh Dewan Redaksi. Kriteria penilaian meliputi orisinalitas, signifikansi dan tata tulis. Dewan Redaksi berhak untuk menerima, menolak, maupun meminta penulis memperbaiki naskah yang diajukan. Naskah-naskah yang dikirimkan kembali ke penulis oleh Dewan Redaksi, perlu ditampung dalam naskah yang direvisi. Walaupun demikian, penulis dapat memberikan argumentasi atas komentar atau saran tersebut. Penulis yang naskahnya diterbitkan dalam Jurnal Ilmiah Elektroteknika Techné akan menerima 2 eksemplar jurnal yang memuat naskah tersebut secara gratis.

Naskah ditulis dalam Bahasa Indonesia atau Bahasa Inggris. Naskah disampaikan dalam bentuk file dengan format sesuai *template* yang dapat diunduh di <http://www.jurnaltechne.org>. *Template* ini sudah memberikan contoh cara penulisan daftar pustaka. Ringkasan ditulis dalam Bahasa Indonesia atau Bahasa Inggris dengan jumlah kata antara 100 hingga 200 kata. Tabel dan Gambar harus diberi nomor secara berturut-tan sesuai dengan urutan pemunculannya. Setiap gambar atau tabel perlu diberi penjelasan.

Alamat surat menyurat:

Editorial:

Dr. Iwan Setyawan

Fakultas Teknik Elektronika & Komputer UKSW,

Jl. Diponegoro 52-60 Salatiga-50711, Jawa Tengah, Indonesia

Telp. (+62)298-311884, (+62)298-321212 ext. 246;

Fax (+62)298-311884.

E-mail: iwan.setyawan@ieee.org

Web: <http://www.jurnaltechne.org>

Surat-menyurat mengenai naskah dikirim dengan menyebutkan judul lengkap, nama pengarang, dan tanggal pengiriman ke alamat di atas.

Berlangganan:

Anggun Arista Yudhiani, A.Md.

Telp : (+62)298-311884;

E-mail: ftek@adm.uksw.edu

Harga berlangganan tiap edisi: Rp. 100.000,- (termasuk ongkos kirim dalam negeri)